

STEP-BY-STEP INSTALLATION INSTRUCTIONS

CertainTeed

OUTDOOR LIVING DESIGNS

RAILING COLLECTION

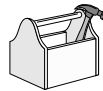

TOOLS YOU WILL NEED

TABLE OF CONTENTS

Tools You Will Need 1

Before You Begin 2

Step 1: Locate and Install Post Supports 4

Step 2: Install Flat Rail 6

Step 3: Install Stair Rail 8

Step 4: Install Rail Connectors and Post Caps 10

Alternate Installations 11

 Wall Mounting

 In Ground Post Installation

Care and Maintenance 12

REQUIRED FOR INSTALLATION

- Chop (mitre) saw**
Can also use a circular, hack, or hand saw
- Saw blade**
Any carbide tipped multi-purpose blade
- Safety glasses**
- 3/8" power drill**
- Drill bits**
1/2" (wood post support) or
1/2" (concrete post support),
3/16" (rail plate),
9/64" (wall mount brackets and rail trim),
1/8" (post caps)
- Screwdrivers**
Slotted and Philips
- Wrenches**
3/4" (post support),
7/16" (E-Z Set Brackets),
3/8" (rail plate)
- Drop cloth**
- 36" Level**
- Wood clamps**
- Carpenter's pencil**
- Tape rule**

OPTIONAL – MAY BE HELPFUL

- 2" hole saw**
- Bevel guide**
- String line**
- File**
- Jigsaw**
- Square**
- Utility knife**

IMPORTANT:

**ALWAYS WEAR SAFETY GLASSES
WHEN CUTTING OR DRILLING
RAILING COMPONENTS.**

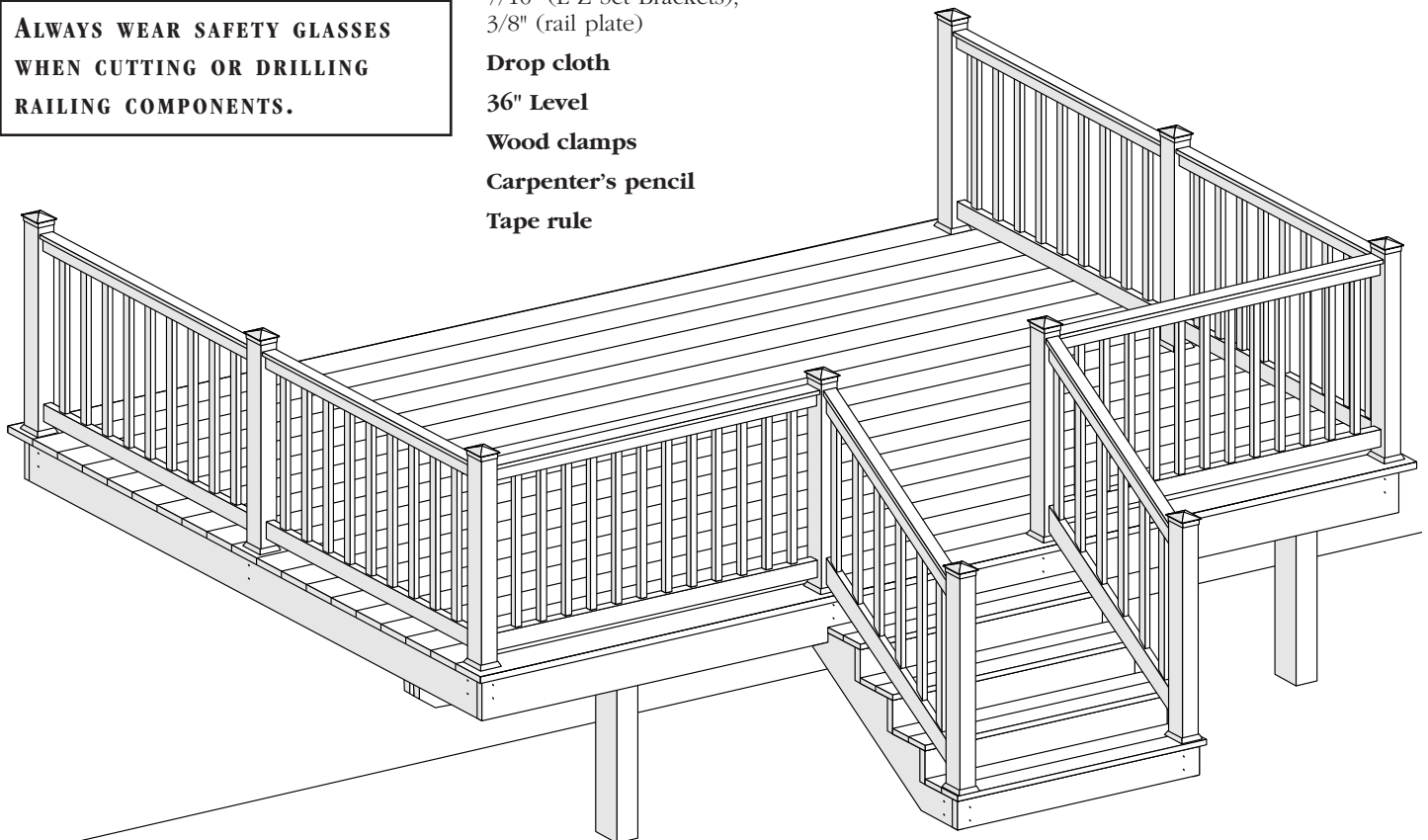

BEFORE YOU BEGIN

MAKE SURE YOU HAVE ALL THE PIECES YOU NEED TO COMPLETE THE JOB.
SEPARATE YOUR FLAT AND STAIR PIECES TO AVOID USING THE WRONG ONES.

1 POST SUPPORTS

FLAT STAIR

Post supports for stair rail are longer than those for flat rail. See table below.



Stair post supports are for **F**, **G**, and **I** posts (also used with **H** posts when positioned at stair bottom).

POST SUPPORT HEIGHT

Railing System	Flat	Stair
3' Wood	42"	53"
3' Concrete	37"	48"
3-1/2' Wood	48"	53"
3-1/2' Concrete	43"	48"

YOUR POST SUPPORT KIT SHOULD INCLUDE:

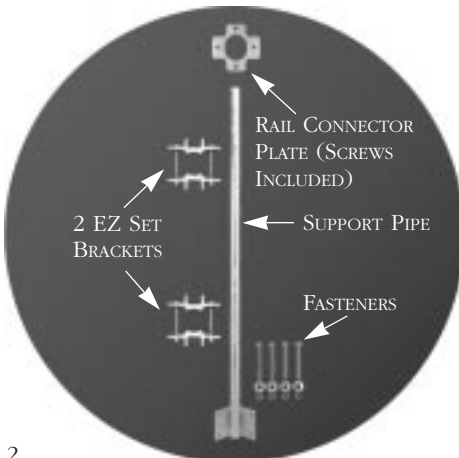

2 POSTS

FLAT

STAIR

Stair posts have widened openings to accept stair angles. See post photo below for detail.



END POST

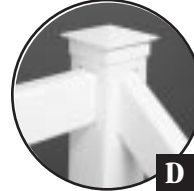

FLAT TO STAIR CORNER LEFT



CORNER POST STAIR

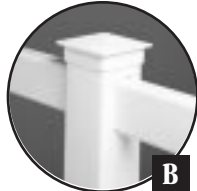

LINE POST



FLAT TO STAIR CORNER RIGHT



FLAT TO STAIR LINE POST

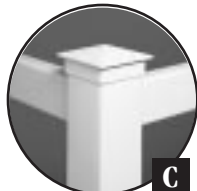

CORNER POST



LINE POST STAIR



END POST STAIR

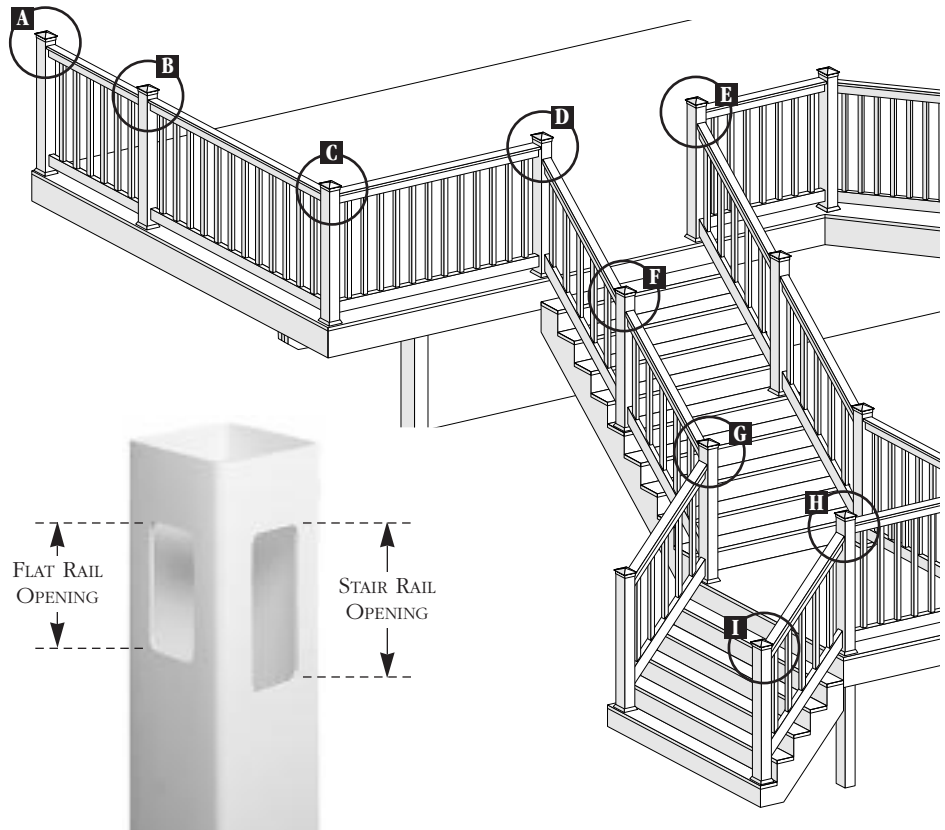

FLAT RAIL OPENING

STAIR RAIL OPENING

3 RAILS

Stair baluster spacing and holes are wider to account for racking. Racking is the tendency of stair balusters to come closer together as the angle of the stairs increases.

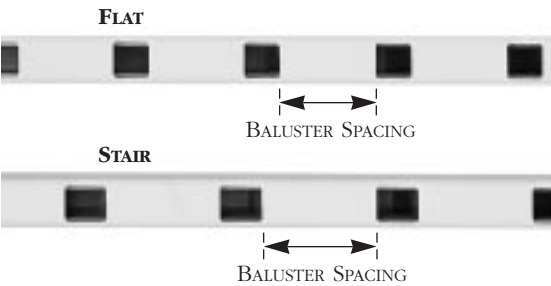

4 BALUSTERS

Flat rail balusters are 1-1/2" longer than stair rail balusters. See table below.



You can cut flat rail balusters down to make stair rail balusters. Do not cut on an angle; cut as shown above. **When cutting Colonial balusters, cut 3/4" off each end.**

Railing System	BALUSTER HEIGHT	
	Flat	Stair
3' Square/Colonial	33-1/4"	31-3/4"
3-1/2' Square/Colonial	39-1/4"	37-3/4"
3' Rectangular	33-1/2"	32"
3-1/2' Rectangular	39-1/2"	38"

5 POST CAPS

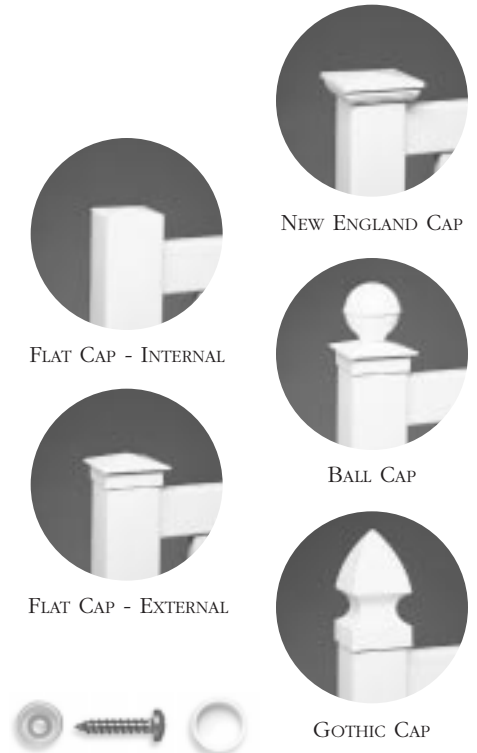

Attach with two PVC Snap Cap fasteners. (no fasteners necessary for internal flat caps)

6 OPTIONAL TRIM



Rail trim can be used to cover rail to wall (or post) connections. Use only with wall mount brackets without plates. See p. 11 for wall mounting.

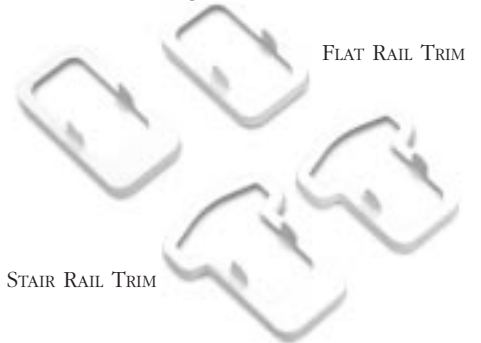

Attach with two PVC Snap Cap fasteners.

1 LOCATE AND INSTALL POST SUPPORTS

Tools Required Steps 1, 2 & 3

Saw
Tape rule
Carpenter's pencil
Safety glasses



APPLICATION TECHNIQUES

You may want to move your post support location 1"-2" to the nearest joist to rim board connection. Moving your post location by this amount is usually not noticeable when the railing is completed.

Bridging can quickly and easily be installed in locations where you do not have two surfaces for mounting post supports.

If you are installing a post on a wood step, your riser opening needs to be finished to provide two surfaces for mounting the post supports.

Alternative post installations (stair bottom) – Concrete walkway or patio: use the concrete mounting post support system. In ground installation: use the "ground mount" stair end post. See p. 11 for installation instructions.

STEP 1. LOCATE AND MARK YOUR POST CENTERS.

For flat sections, make sure your post centers are no more than 96" apart.

For stair sections, determine if the rail will reach the bottom of the steps (or the landing). Place a rail on the stringer (make sure the rail extends beyond the top post support). If the rail does not reach the end of the stairs, you will need to use an intermediate post. For standard 7" rise and 11" run, 6' rail measures 57" between post centers and 8' rail measures 78" between post centers.

STEP 2. CHECK YOUR SUBSTRUCTURE.

Once you have located your post centers, check your substructure to determine if you need to make any changes in your post center locations or to the substructure (see "Application Techniques").

STEP 3. DETERMINE RAIL AND POST HEIGHT.



Standard post heights are 38" (3' rail) and 44" (3-1/2' rail). For railings with greater than 2" bottom rail clearance, longer post supports are required.



Cut a vinyl post to the desired height for use as a guide for installing your post supports.

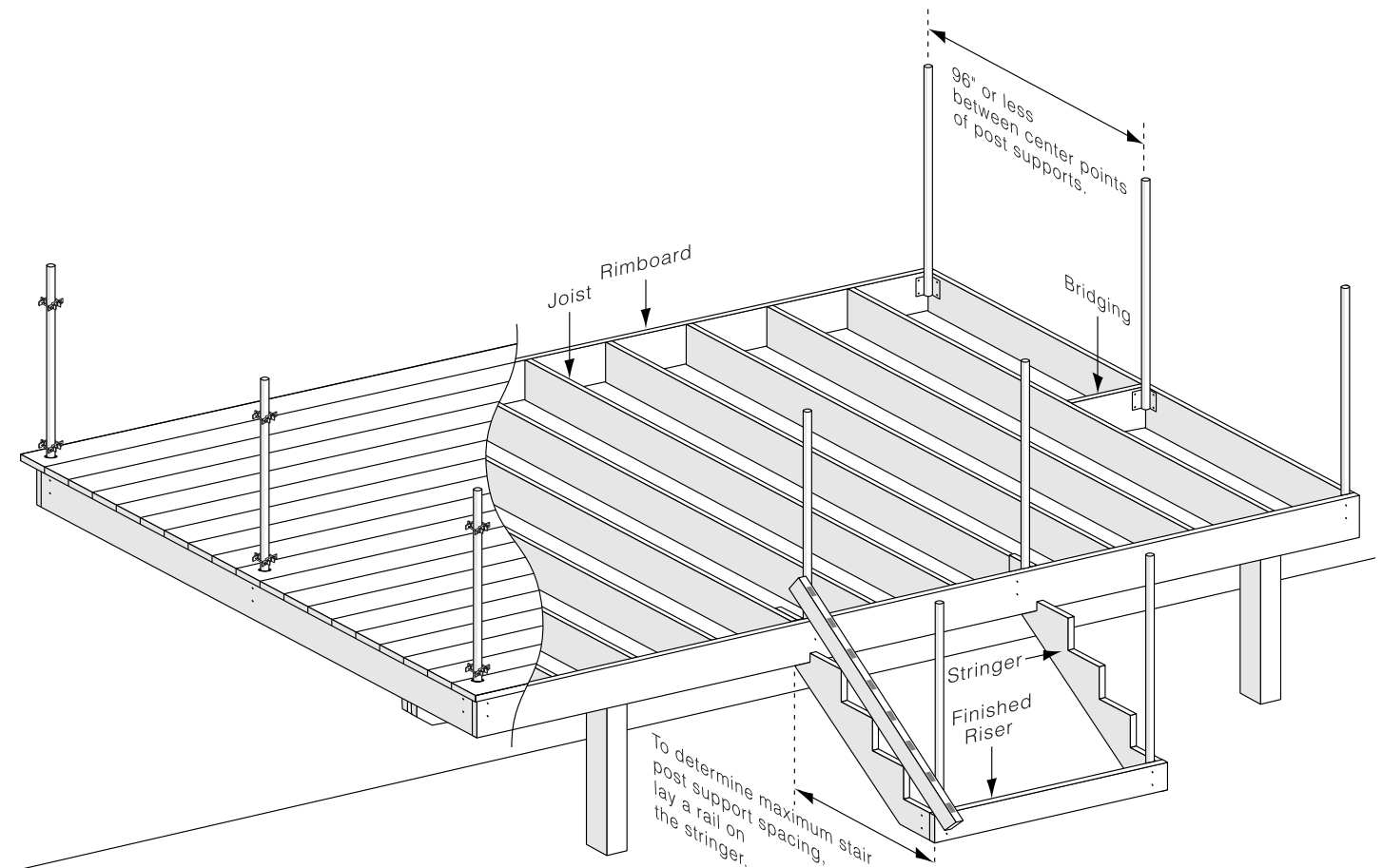

STEP 4. INSTALL POST SUPPORTS.



Clamp post supports in place. Check post support height. Support must be above opening (approx. 3/4"). Level post support.



Use the post support as a guide and drill four 1/2" holes.



Insert all four fasteners, then tighten. Recheck level.



If your joists are not plumb, use a washer as a shim to level the post support.

STEP 5. INSTALL DECK BOARDS.



Saw or notch deck boards to accept 1-5/8" post support. Install deck boards.

STEP 6. INSTALL EZ SET BRACKETS.

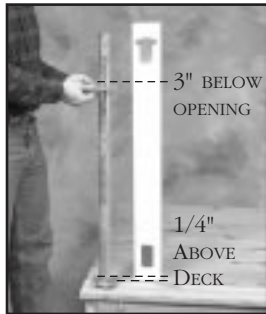

Assemble E-Z Set Brackets. Position as shown at left. Hand tighten.

Note: Top bracket can be installed later for added security. See page 10 for optional installation.



Slide post over support and brackets, then position post to intended rail layout. This will align your E-Z Set Brackets.



Remove vinyl post, taking care not to twist the post. Tighten the E-Z Set Brackets with a wrench.

MOUNTING OPTIONS

POST SUPPORT APPLICATION ON A WOOD DECK

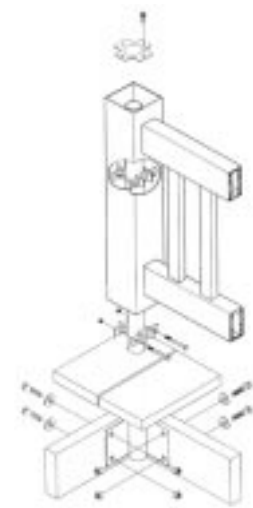

Tools Required Steps 4, 5 & 6

3/8" drill	Tape rule
1/2" wood drill bit	Two 3/4" wrenches
Clamps	Saw
Level	Two 7/16" wrenches
Safety glasses	

POST SUPPORT APPLICATION ON CONCRETE

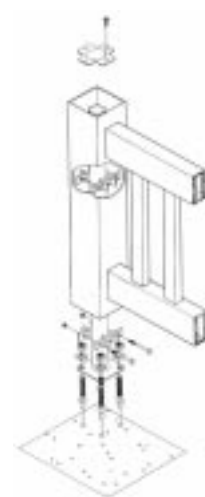

Tools Required Steps 4, 5 & 6

3/8" drill	One 3/4" wrench
1/2" masonry drill bit	Carpenter's pencil
Level	1/2" washers
Tape rule	Saw
Safety glasses	Two 7/16" wrenches

2 INSTALL FLAT RAILING SECTIONS

Tools Required

Saw
Tape rule
Carpenter's pencil
Square (optional)

Safety glasses



APPLICATION TECHNIQUES

Begin your railing project by first installing the flat sections. Work your way towards the steps.

Work one section at a time. Only cut the rails for the section you are working on (post center widths may vary slightly).

Do not fasten the rail connector plates until the entire job (flat and stair sections) is installed.

STEP 1. CUT ALL OF YOUR FLAT SECTION VINYL POSTS.

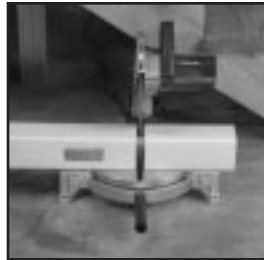

Use your previously cut post as a guide to measure and cut each post.

**IMPORTANT
WEAR SAFETY
GLASSES.**

STEP 2. INSTALL VINYL POSTS.



Slide post over support. Install post trim piece at this time (optional).

STEP 3. INSTALL RAIL SECTIONS.

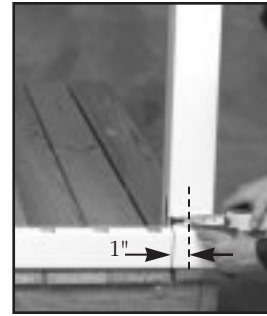

Lay bottom rail between posts with both end holes clear of posts and equally spaced. Mark rail 1" longer than points where rail and post meet.



Cut bottom rail, keep aluminum inside flush with vinyl on both ends. Use bottom rail as a guide to cut top rail.

**IMPORTANT
WEAR SAFETY
GLASSES.**

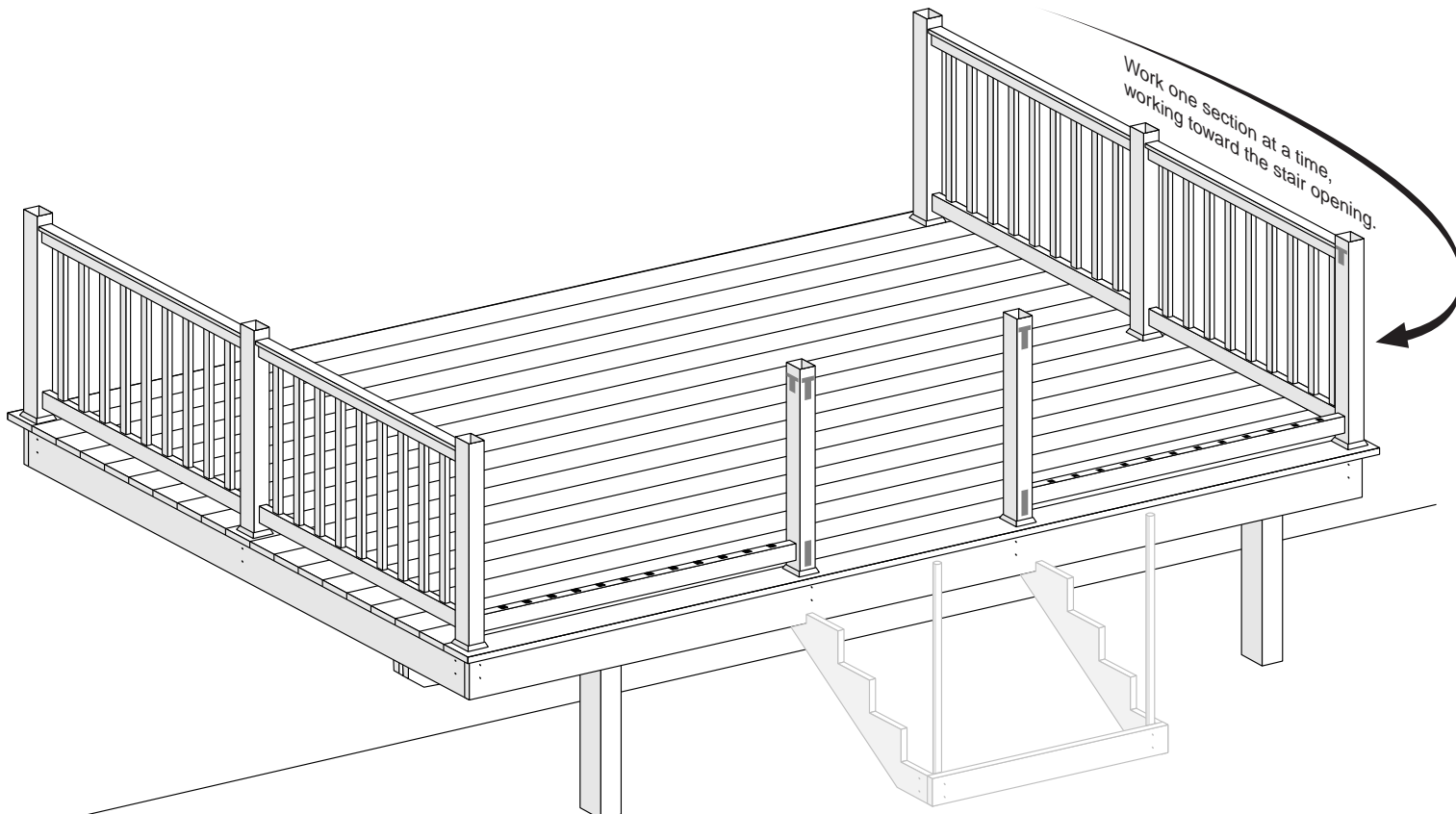



Insert bottom rail into post.



Position top rail over balusters. For convenience, rest the high end of the rail on the next post.



Lift the partially assembled section and insert top rail into opening. Push section down to deck.



Lift next post and insert rail into opening. Push post and rail down to deck.



Pull up on the first few balusters and insert them into the top rail holes.

- Repeat Step 3 for the second, third, etc. sections.



Insert balusters into bottom rail.



Push down on top rail and position next to the opening. The rail may not fully enter into the opening until you have inserted more balusters.

3 INSTALL STAIR RAIL

Tools Required

Saw
Tape rule
Carpenter's pencil
Square (optional)

Bevel guide
Safety glasses



STEP 1. INSTALL BOTTOM POST SUPPORT AND POST.



Install stair post support and E-Z Set Brackets. (Do not cut support)



Slide post over support. (Do not cut post)

STEP 2. CUT YOUR RAIL TO YOUR STAIR ANGLE AND LENGTH.



Lay bottom rail between posts with end holes clear of posts and equally spaced. Mark vertical lines on both ends of the rail where it meets the posts.

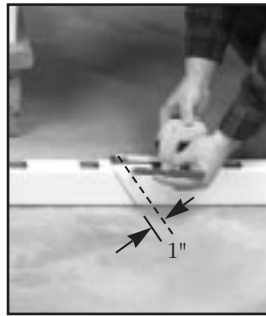

Move your angle line outward 1" on both ends to account for extra length inserted into the post.



Cut your stair rail to the exact angle that you traced. Make sure the aluminum rail insert is flush with the end of the vinyl rail.

IMPORTANT WEAR SAFETY GLASSES.

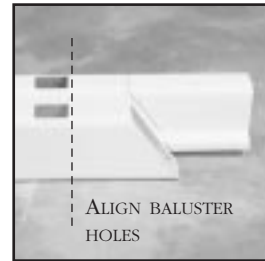

Use bottom stair rail as a guide for cutting your top rail. Line up baluster holes, trace the angles and cut.

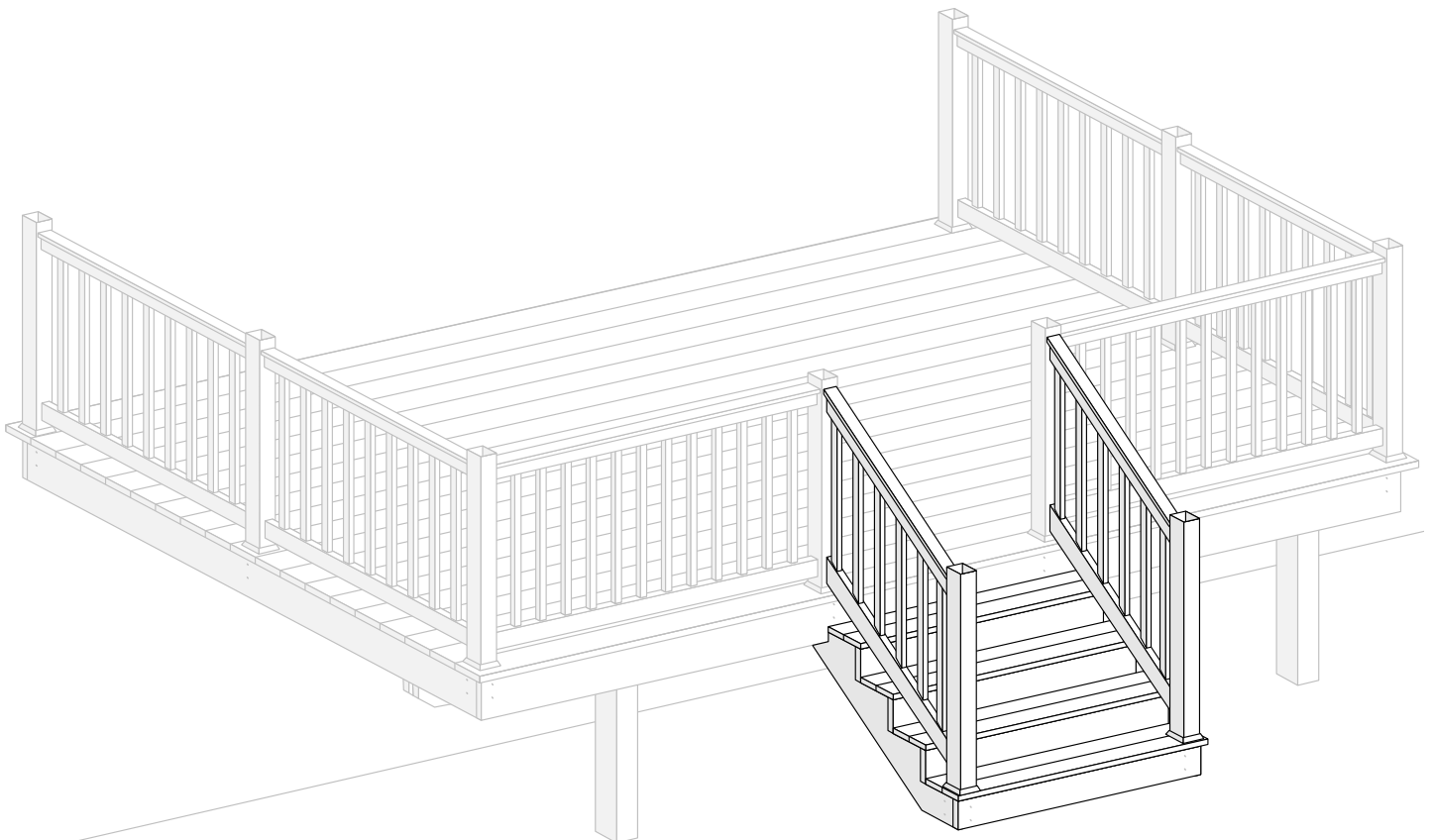

STEP 3. CUT BOTTOM STAIR POST TO THE PROPER HEIGHT.



Insert bottom rail into upper post. Clamp rail to lower post at desired height. Measure distance from point where rail and post meet down to stair tread.

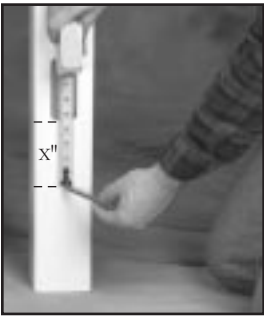

Remove lower post and transfer your previous measurement as shown.



Cut your post along your mark.

STEP 4. CUT STAIR POST SUPPORT.

Use the previously cut stair post as a guide to determine post support height. Place stair post on step next to post support and mark support at $3/4$ " above top rail opening. Remove support and cut at your mark. Reinstall post support.

STEP 5. ASSEMBLE STAIR RAIL SECTION.



Slide stair post over post support. Insert bottom rail into lower post. *You may find it easier to lift the lower post, insert the bottom rail, then lower the post.*



Lift upper post 3" to 4" until you can insert the bottom rail, then slide it back down.



Insert balusters into bottom rail. Insert balusters into top rail, then insert top rail into lower post.



Lift the partially assembled section and insert top rail into opening. Push section down to deck.

4

INSTALL RAIL CONNECTORS AND POST CAPS

Tools Required

Saw Safety glasses
 Drill
 3/16", 1/8" drill bits
 Screwdriver or 3/8" wrench



INSTALL RAIL CONNECTORS

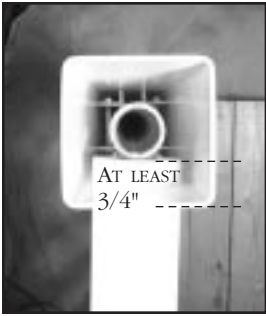

Make sure the vinyl rail and aluminum insert project to at least 3/4" inside the post.



Insert rail connector plate over post support as shown at left. Drill a 3/16" hole through the rail and aluminum insert. Do not drop the plate into the post.



Attach the plate to the rails using the screws provided in your post support kit.

CORNER APPLICATION



To install a rail connector on a corner post with T rail, cut off 1" at a 45° angle on the inside corner of each rail. You need only cut the vinyl portion of the rail.

STAIR APPLICATION



Position the flange at the long ends of the oval over the stair rail. As you screw the rail plate, apply enough torque to bend the flange to the rail angle.

INSTALL POST CAPS.

The internal flat cap simply snaps into the post.

External caps must be secured to the posts. Drill 1/8" pilot holes on each side of the cap. Insert screw, washer, and PVC snap cap into each hole.



FLAT CAP - INTERNAL



FLAT CAP - EXTERNAL



NEW ENGLAND CAP



BALL CAP



GOTHIC CAP

OPTIONAL INSTALLATION: RAIL SYSTEM ANCHOR



For added security install top E-Z set bracket after rail plate.

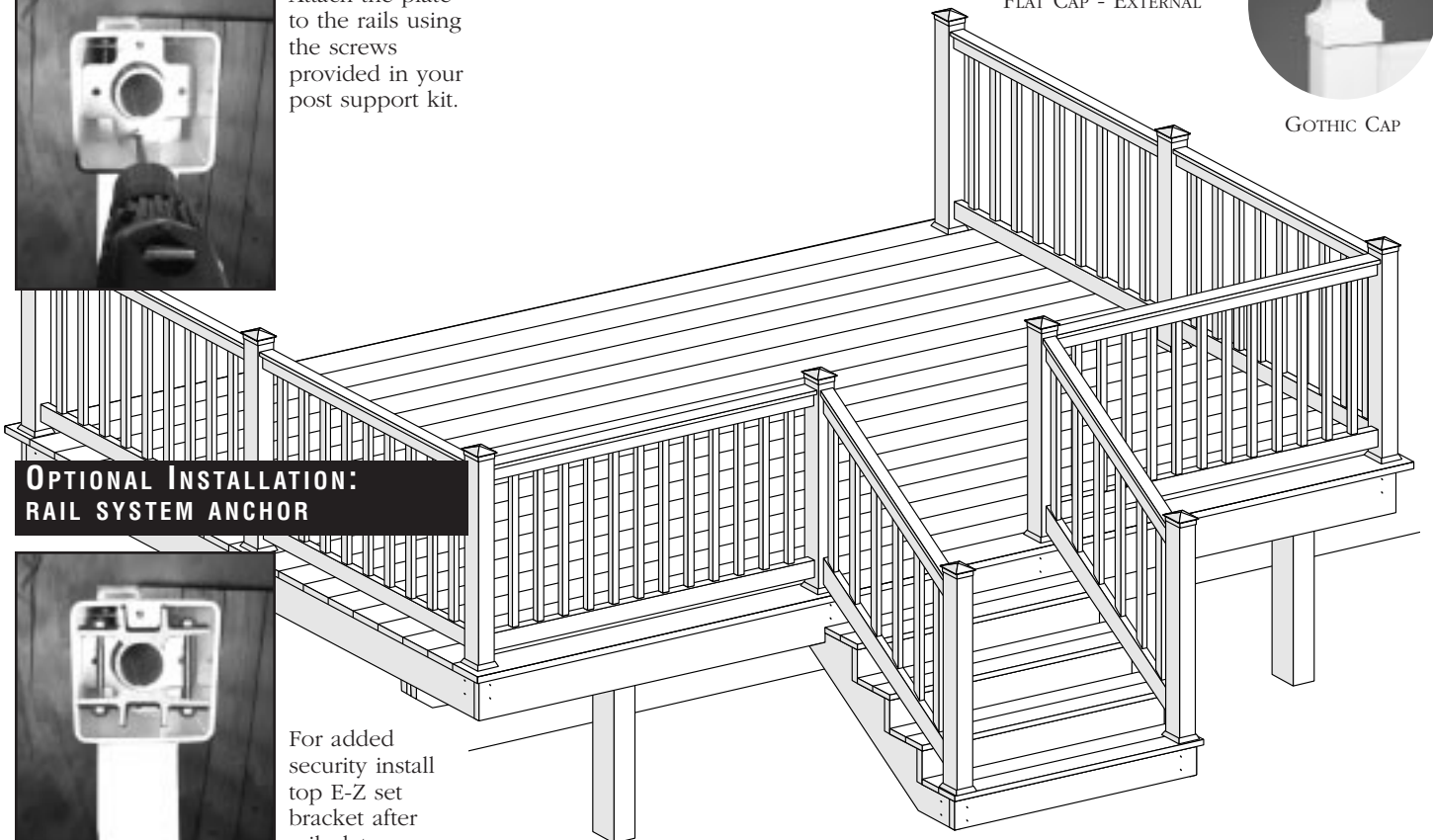

ALTERNATE INSTALLATIONS

Tools Required

Saw
Drill
1/4", 9/64" drill bits
Screwdriver

Safety glasses



WALL/COLUMN MOUNTING

Railings can be mounted to walls or columns using wall mount brackets. Wall mount brackets must be anchored securely to assure a safe installation. The installer must determine if the structure to be mounted to is solid and that the appropriate fasteners are used.

WALL MOUNT BRACKETS WITHOUT PLATES

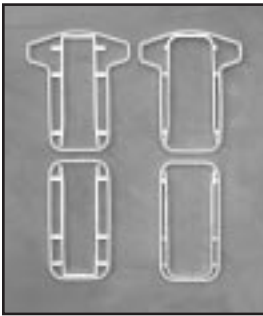

Cut off a 1/4" piece from the top and bottom rail to use as a template for positioning your bracket.



Insert a bracket into the bottom rail template and position the template to your desired rail location. Drill your 1/4" holes and insert your fasteners.

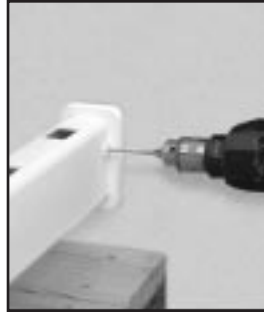

Slide your rail and optional rail trim cover over the bracket. Drill a 9/64" wide hole through the tab on both sides of the rail.



Fasten with PVC Snap Cap Fastener. Caution: over-tightening screws can result in a poor fit for the Snap Cap Cover.



Position your template to the desired top rail location and repeat the previous steps.

WALL MOUNT BRACKETS WITH PLATES



Insert bracket into rail and center bracket. Drill and fasten bracket to rail as previously shown. Note: brackets with plates do not need trim pieces and are fastened in the middle of the rail.



Install bottom rail, insert balusters and install top rail. Be sure you are mounting to a solid surface and that you use the appropriate fasteners.

INSTALLING RAILINGS AT ANGLES

CertainTeed provides a template kit that can be used to custom route posts to accommodate various railing layouts. Ask your dealer for full details.

DOVER/HAMPTON BRACKETS



FLAT

STAIR

OXFORD/CAMBRIDGE BRACKETS



FLAT/STAIR

WORKS FOR BOTH FLAT AND STAIR APPLICATIONS

RAIL DIMENSIONS

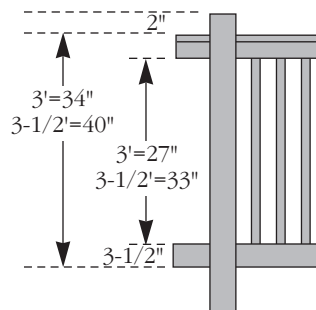

IN GROUND POST INSTALLATION

For 3' rail use 72" post, for 3-1/2" rail use 76" post. To install: dig a 10" diameter hole to a depth below the frost line approximately 30". Put the post in the hole and place 4" of gravel or dirt in the hole for drainage. Fill the hole with concrete until the concrete is 2" from the top of the hole. Tamp the concrete with a 2x4 to eliminate air pockets. Check your post for square and level. Prior to installing your railing, reinforce the entire height of the post with two pieces of 1/2" rebar. Insert your rails and baluster. Fill the post up with concrete to just above the top rail. Tamp the post with a rubber mallet to avoid air pockets.

CARE AND MAINTENANCE

While CertainTeed vinyl railing resists most common household stains, including oil and grease, it will become dirty like any other product that is exposed to atmospheric conditions. Chalk may also accumulate on the surface. This is a normal condition for all pigmented materials that are constantly exposed to sunlight and the elements. Soil, grime and chalk can be simply removed with the help of your garden hose and a bucket of soapy water.

Mildew may be a problem in some areas. It appears as black spots on surface dirt and is usually first detected in areas not subjected to rainfall, such as under eaves and porch enclosures. For removal, prepare a solution as shown.

CAUTION: greater concentrations may cause damage to the vinyl materials.

Mix together:

- 1/3 cup detergent (Tide, for example)
- 2/3 cup Trisodium Phosphate (Soilax, for example)
- 1 quart 5% Sodium Hypochlorite (Clorox, for example)
- 3 quarts of water

If the above solution does not readily remove the mildew spots, purchase a mildew-type cleaner.

If especially stubborn stains cannot be removed with normal household detergents, always test the cleaner on an inconspicuous area before full use.

The chemical agents referenced herein may be hazardous to the user or the environment. Be sure to follow all precautions and warnings on the product label, and particularly those which may be necessary to prevent personal injury. Please dispose of these chemical agents in a manner prescribed by the manufacturer. If you are unsure how to use or how to dispose of these chemical agents, contact the manufacturer of these products for instructions.

IMPORTANT: FIRE INFORMATION

Exterior vinyl building materials require little maintenance for many years. Nevertheless, common sense dictates that builders and suppliers of vinyl products store, handle and install vinyl materials in a manner that avoids damage to the product and/or the structure. Owners and installers should take a few simple steps to protect vinyl building materials from fire. Rigid vinyl railing is made from organic materials that will melt or burn when exposed to a significant source of flame or heat. Building owners, occupants and outside maintenance personnel should always take normal precautions to keep sources of fire, such as barbecues, and combustible materials, such as dry leaves, mulch and trash, away from vinyl railing.



ATTENTION CONTRACTORS GET A FREE HAT!

If you have a tip, hint, or solution to a difficult installation problem, please send it to us along with your name and address and CertainTeed will send you a free hat. We value your experience and appreciate your input!

Send your tip to:

CertainTeed Corporation
attn: "Product Engineering"
2525 Walden Avenue
Buffalo, NY 14225

CertainTeed

Quality made certain. Satisfaction guaranteed.

CERTAINTEED CORPORATION
2525 WALDEN AVENUE, BUFFALO, NY 14225
WWW.CERTAINTEED.COM

© 1/99 CERTAINTEED CORPORATION
CODE NO. 40-70-823